



Forging a Pathway to a 100% Renewable Energy Future

Board of Selectmen Meeting, February 15, 2017

Presented by the Simsbury Clean Energy Task Force

100PercentCT

Project Vision

We seek to produce viable, replicable plans for individual towns to transition to 100% renewable energy by 2050. Key steps include:



- Benchmarking of current energy usage for *entire* town
- Comprising electricity, heating/cooling, transportation
- Investments in efficiency and conservation
- Electrification of heating, cooling and transport
- Granular analysis of potential for renewables (solar PV)
- Sensitivity to preserving town's character and farmlands
- Design of local microgrid(s) with generation & storage
- Engage with utilities to test “utility of the future”

As these plans are implemented, they offer multiple benefits to towns, including lower energy costs for residents and businesses, greater storm resiliency, better health and greater attractiveness to future generations.

Let's “do the math” and see if we can make it work!

We start by estimating current energy usage

- We include the whole town: residential, commercial and municipal.
- Electricity and natural gas usage was provided by Eversource and CNG.
- We estimate heating oil use from the Simsbury building list.
- We estimate transportation use from the Simsbury vehicle list.
- We convert all figures to a common unit: Gigawatt-Hours (GWh).
- Detailed calculations shown in Appendix.

Current Energy Usage (GWh)

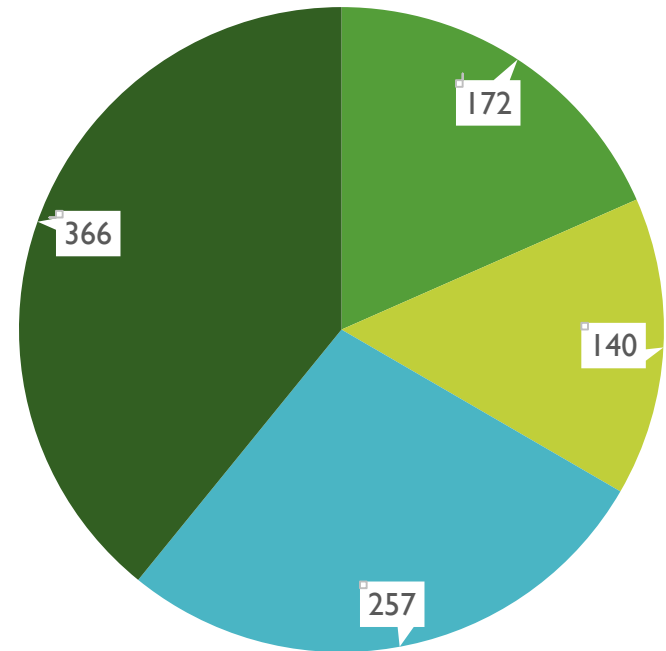

We explore the potential to reduce usage

- Energy-efficient appliances and devices.
- Modern design techniques and technology on new buildings and energy retrofits.
- Adoption of renewable thermal technology (i.e., heat pumps) for heating and cooling.
- Adoption of electric vehicles.
- Potential savings are substantial (GWh):

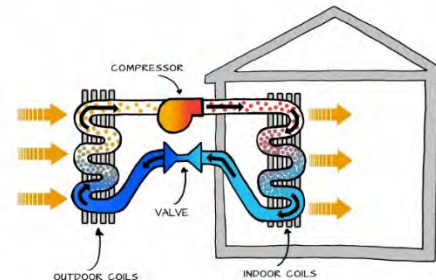

	Current	New	Savings
Electricity	172	137	34
Heating	397	105	292
Transportation	366	83	283
Total	934	325	609



How much can we generate locally?



10/27/17

First estimate: 1/3 local, 2/3 regional

- We estimate one-fourth of homes could install solar with an average 7 kW array (~25 panels).
- We use the same assumption for small commercial buildings.
- We have modeled almost all large commercial buildings using the tool Helioscope.
- We have modeled some parking lots and identified other potential sites.
- We anticipate at least 5 possible sites on undeveloped land (without encroaching on open space or farmland).
- Remaining need will come from *regional* renewable sources.

Location	Number	Annual Production (GWh)
Residential-Homes	8,250	17.3
Residential-Other	754	7.5
Commercial-Small	344	0.7
Commercial-Large	47	5.5
Subtotal Buildings	9,395	31.0
Parking Lots	30	12.0
Undeveloped Land	5	75.0
Total		118.0

These initial estimates are preliminary; and will likely prove to be conservative (low).

Bringing it all Together

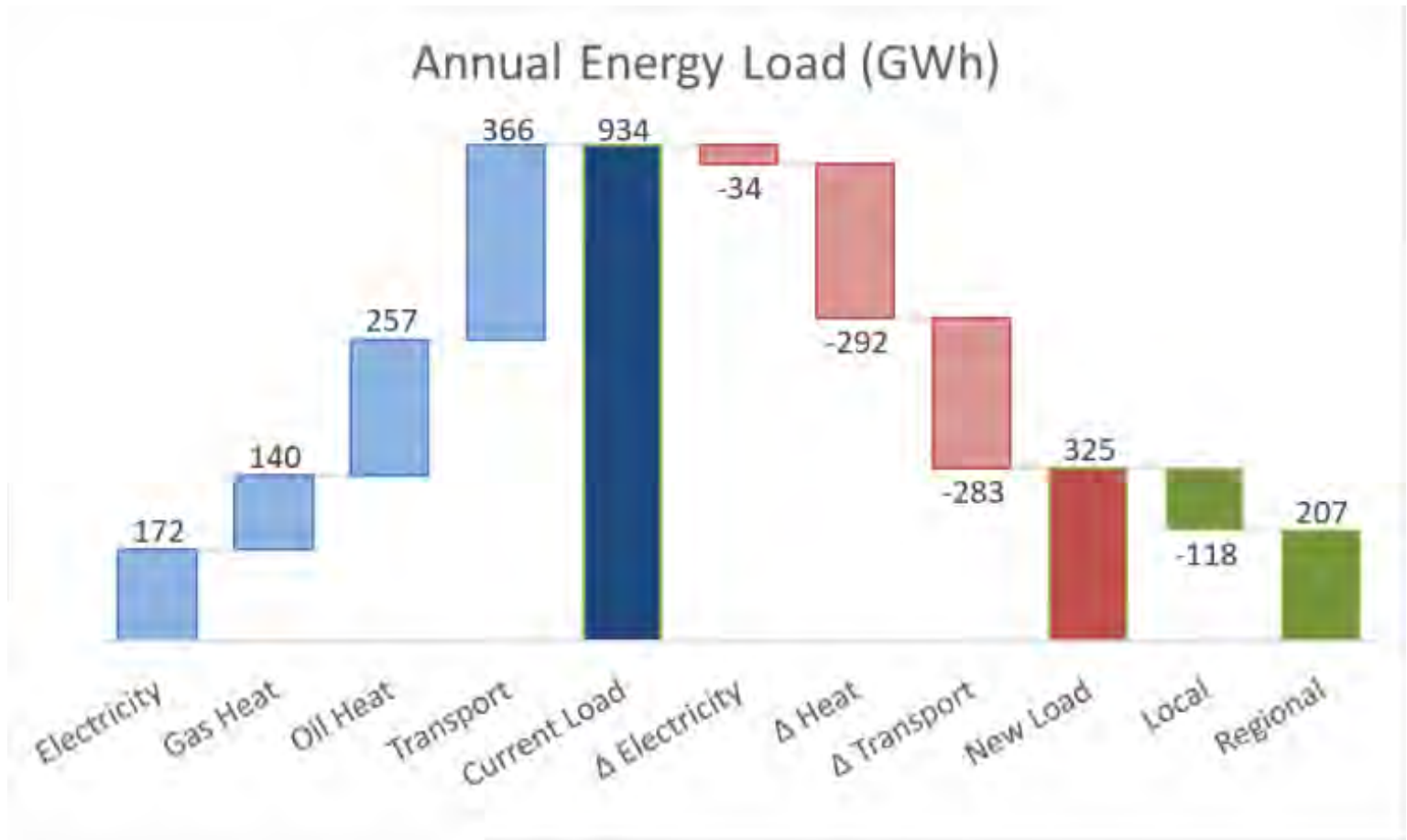

- Figures in chart are for the town of Simsbury, and are highly preliminary, based on our analysis to date.
- In addition to annual energy use, we will review various scenarios (e.g., peak loads) and greenhouse gas emissions.

We need to re-think the electric grid

- Current grid was designed for large, centralized power plants sending electricity in one direction to consumers
- Future grid must handle:
 - Distributed generation
 - Multi-directional flows
 - Intermittency of renewables
 - Storage
 - Demand response
 - Resiliency & security

Current Grid Design

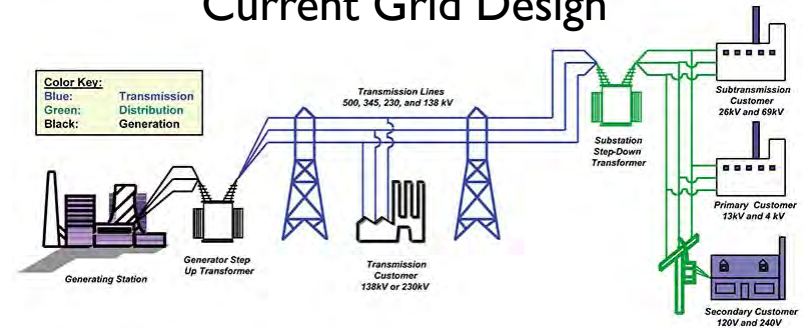

Future Grid Design

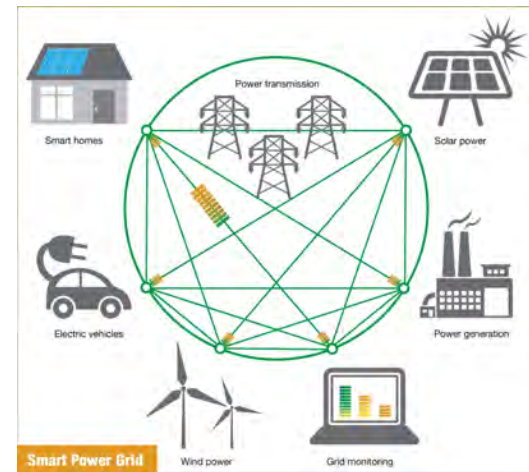

We are working collaboratively with Eversource and the non-profit Clean Coalition to develop a Community Microgrid pilot project.

The path ahead, or “making it happen”

- Initial project focus is technical feasibility.
- Timeframe is 30-35 years (i.e., by 2050).
- We are already identifying key pathways (and obstacles).
 - We believe the project will create options that don't currently exist, or are not visible.
- Potential future steps include:
 - Collaboration with Eversource to develop pilot microgrid,
 - Town-wide programs to educate on and promote:
 - Renewables (e.g., solar)
 - Heat pumps
 - Energy-efficient retrofits and new construction
 - Commercial energy efficiency measures
 - Community shared solar “farms” / “gardens”
 - Electric vehicle charging infrastructure
- We are already working to embed the project's aspirations into Simsbury's Plan of Conservation and Development (PoCD).

Project philosophy is to generate possible solutions and work collaboratively to achieve them.

Our Project Partners



Clean ⚡ *Coalition*

**Yale School of Forestry and
Environmental Management**

**Institute for Sustainable Energy
Eastern CT State University**



APPENDIX

Current energy usage: Electricity

Customer Class	2013		2014		2015	
	# of Accounts	Consumption (GWh)	# of Accounts	Consumption (GWh)	# of Accounts	Consumption (GWh)
COMMERCIAL-HEATING	48	7.5	47	7.4	52	6.9
COMMERCIAL-NON HEATING	792	55.5	807	57.0	812	57.2
COMPANY USE	2	1.3	2	1.3	2	1.3
INDUSTRIAL/MANUFACTURING	5	10.9	6	10.7	5	11.7
LIGHTING	18	0.3	18	0.3	18	0.3
RESIDENTIAL SPACE HEATING	1,239	13.7	1,245	14.1	1,290	13.7
RESIDENTIAL-NON HEATING	9,075	83.4	9,110	80.8	9,464	80.3
Grand Total	11,179	172.6	11,235	171.7	11,643	171.5
Subtotal Residential	10,314	97.1	10,355	94.9	10,754	93.9
Subtotal Commercial	865	75.5	880	76.8	889	77.6
of which Municipal		3.9		4.3		4.2
Other Commercial		71.6		72.5		73.4

- Eversource provided 3 years of data, split by categories shown.
- Commercial categories include municipal data; we split these out using data from the town.

Current energy usage: Natural gas

Customer Class	CCF			GWh		
	2013	2014	2015	2013	2014	2015
CNG Residential Heating Off-Main Distr		0	13,944		0.0	0.4
CNG Residential Heating On-Main Dist		12,774	61,051		0.4	1.8
CNG Res Multi-dwell Large for Distri	44,998	52,634	45,735	1.3	1.5	1.3
CNG Res Multi-dwell Small for Distri			1,289			0.0
CNG Residential General for Distribution	1,165	1,303	1,640	0.0	0.0	0.0
CNG Residential Heating for Distribution	1,668,676	1,841,006	1,821,900	48.4	53.4	52.8
CNG Seasonal - Residential for Distri	1,067	496	500	0.0	0.0	0.0
Subtotal Residential	1,715,906	1,908,213	1,946,059	49.8	55.3	56.4
CNG Non Res Large Gen Serv for Distri	1,226,561	1,543,728	1,410,220	35.6	44.8	40.9
CNG Non Res Med Gen Service Off-Main Dis			46			0.0
CNG Non Res Med Gen Service On-Main Dist		2,324	21,107		0.1	0.6
CNG Non Res General Service for Distri	1,010,091	1,151,644	1,093,700	29.3	33.4	31.7
CNG Natural Gas Vehicle	1,270	787	852	0.0	0.0	0.0
CNG Non Res Small Gen Service Off-Main D			1,454			0.0
CNG Non Res Small Gen Service On-Main Di		17	6,272		0.0	0.2
CNG Non Res Small Gen Serv for Distri	317,803	386,739	342,629	9.2	11.2	9.9
Subtotal Commercial	2,555,725	3,085,239	2,876,280	74.1	89.5	83.4
Grand Total	4,271,631	4,993,452	4,822,339	123.9	144.8	139.8
Municipal	56,690	69,360	67,930	1.6	2.0	2.0
Other Commercial				72.5	87.5	81.4

- CNG provided 3 years of data, split by categories shown.
- Commercial categories include municipal data; we split these out using data from the town.
- Conversion rate: 1 CCF = 29 KWH

Current energy usage: Heating oil

Number of Buildings in Town Heating with Oil

Residential	5,380
Remainder	534
Total	5,914

Avg. # Gallons Heating Oil Consumed per year 987

Total Consumption	Gallons	GWh
Residential	5,310,060	233.6
Remainder	527,058	23.2
Total	5,837,118	256.8

- List of buildings heating with oil comes from town Grand List.
- Avg. heating oil consumption from Mass. Dept. of Energy Resources, <http://www.mass.gov/eea/energy-utilities-clean-tech/misc/household-heating-costs.html>
- Conversion rate: 1 Gallon = 44 KWh

Current energy usage: transportation

	Number of Vehicles	Miles per Year	Miles per Gallon	Gallons per Year (000)	GWh per Year
Residential	16,923	13,000	23	9,565	319.6
Commercial	2,465	13,000	23	1,393	46.5
Total	19,388			10,958	366.1

- List of vehicles comes from town Grand List.
- Annual miles driven and miles per gallon from U.S. DOT
- Conversion rate: 1 Gallon = 33.4 KWh

Estimated new energy usage

	Current	New	Savings
Electricity Consumption	171.7	137.3	34.3
Percent Savings		20%	
Heating and Cooling			
Number of Buildings		9,722	
Avg. Usage (KWh)		10,794	
Total Usage (GWh)	396.7	104.9	291.7
Transportation			
Number of Vehicles		19,388	
Av. Miles per Year		13,000	
kWh per mile		0.33	
Total Usage (GWh)	366.1	83.2	282.9

- For current electric consumption, we assume 20% potential savings due to efficiency measures (e.g., LED bulbs, energy star appliances)
- For heating and cooling, we assume a transition to air source heat pumps, with annual consumption figures from www.energystar.gov
- For transportation, we assume the electrification of all vehicles, with energy usage of 0.33 KWh per mile.

We modeled individual rooftops and parking lots

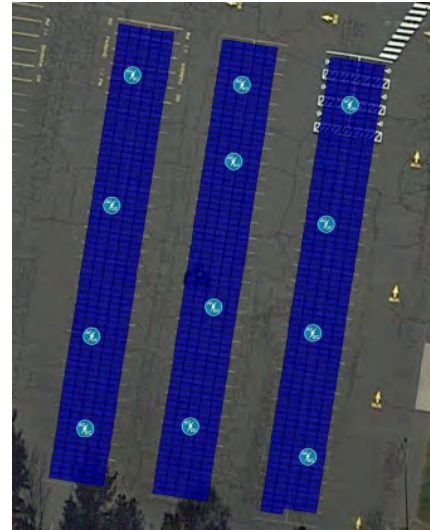

Overview of a Community Microgrid

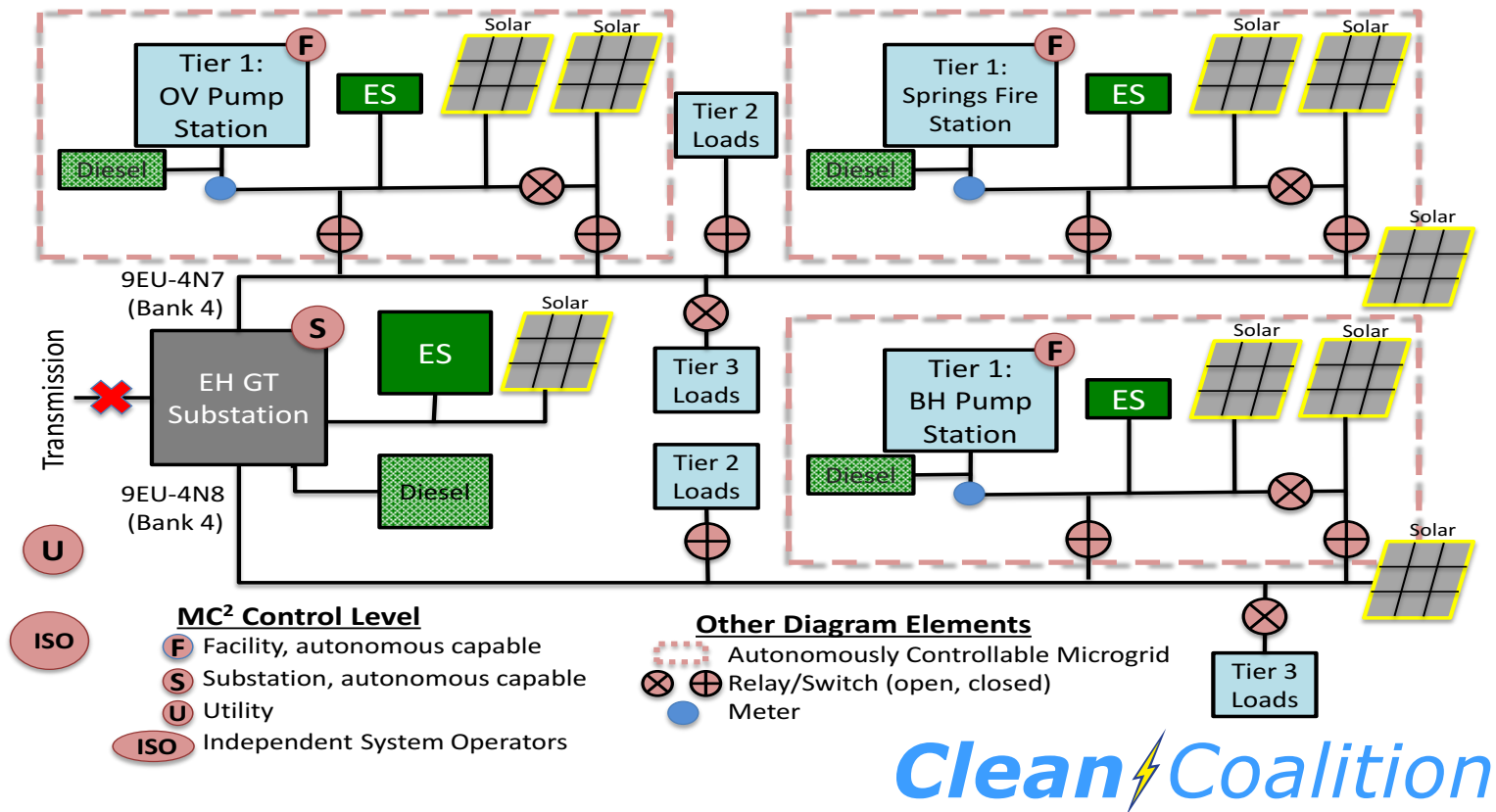

We are working collaboratively with Eversource and the non-profit Clean Coalition to develop a Community Microgrid pilot project.